

## Single needle direct drive straight lock stitcher with thread trimmer

### S-7200A

- Good response and smooth sewing performance
- No staining of the product
- Easy-to-understand and easy-to-use operation panel
- Comfortable operation with low noise and low vibration
- Easy to maintain
- Economical to use with low power consumption



*Brother was the first in the industry to release direct-drive plain lockstitchers. The S-7200A is our leading DD lockstitcher which has been developed from many years of research and success in the market.*

### Smooth sewing with direct drive system

The direct-drive system optimizes the plain lockstitching processes that require operator control. The direct-drive mechanism provides superb levels of reliability through the use of a unique built-in direct-drive motor developed by Brother. The S-7200A provides greater responsiveness to the operator's intentions. Minute speed adjustments can be made as required when sewing curves to make sewing even smoother.

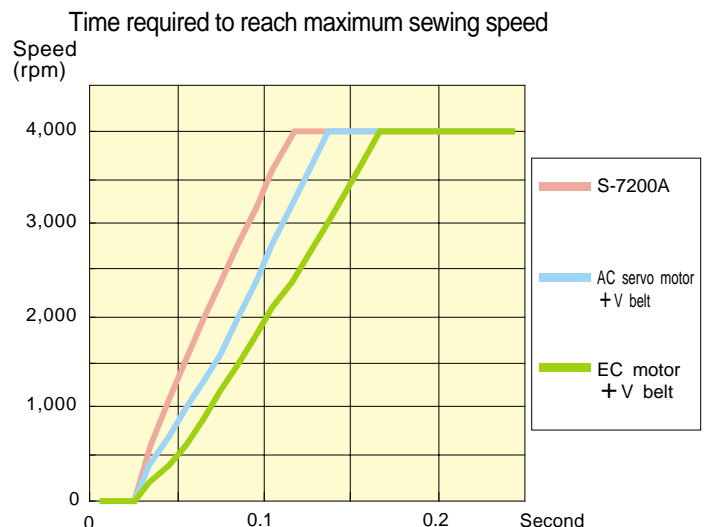
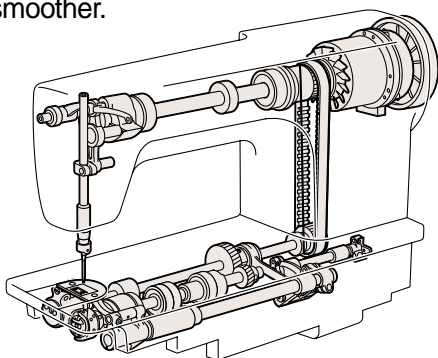

## Clean sewing with no staining

This model utilizes Brother's advanced lubrication-free technology. Sewing operations are freed from the problem of staining the workpiece. The following three sub-classes are available.

- **Complete dry type (– 45□)** Max. sewing speed 4,000rpm

A lubrication-free rotary hook is used, and no oil is used around the needle bar, thread take-up or rotary hook mechanism.

- **Semi dry type (– 43□)** Max. sewing speed 5,000rpm

A sealed oil tank is used. The oil is kept clean at all times, and only the rotary hook is lubricated. A lubrication-free hook is optionally fitted to the use strictly up to 4,000 rpm

- **Minimum lubrication type (– 40□)** Max. sewing speed 5,000rpm

A sealed oil tank is used. The oil is kept clean at all times, and it is supplied at the minimum quantity required to enable high-speed sewing to be carried out.

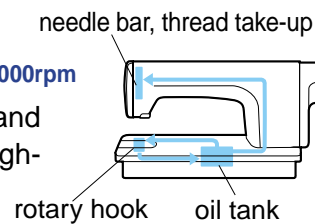
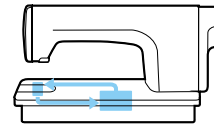
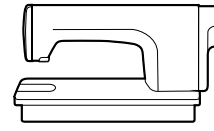

Sealed oil tank

## Easy-to-understand and easy-to-use operation panel

- **Easy access to the required functions**

The most commonly-used functions are located at the front of the L-shaped panel. A symmetrical layout has been adopted as the user interface to make the function locations easy to remember. Plus, they are grouped and color-coded by the type of function so that you can easily find what you are looking for.

- **Easy-to-understand two-color graphic display**

A two-color LCD panel has been adopted. The display details can be identified by color, and easy-to-understand icons are also used.



- **Digital setting of maximum sewing speed**

The maximum sewing speed can be easily set using the digital operation panel.

- **Sewing speeds are displayed in a sewing speed control display**

The sewing speed can be changed easily at the control display, which allows the operator to check the sewing speed visually.



- **Easy setting using function key**

Settings relating to sewing machine operation can be carried out at a touch using the function keys on the operation panel.

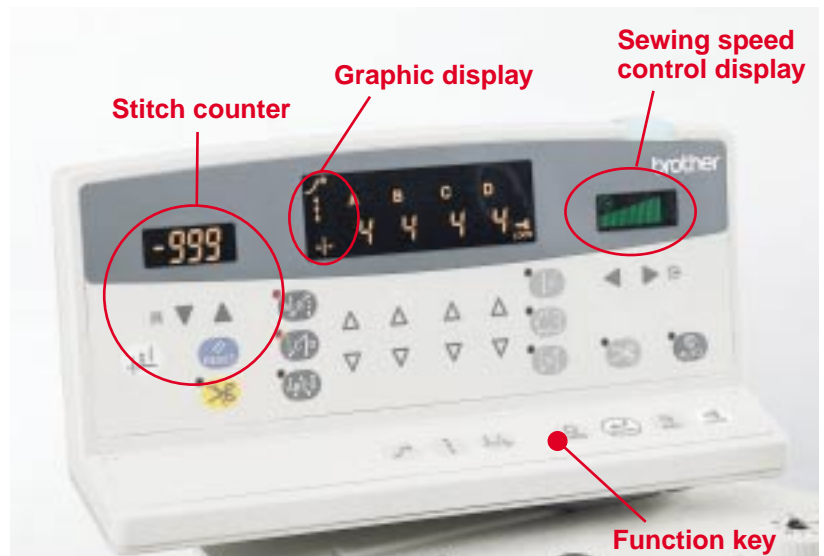

- **The number of stitches is counted**

The number of stitches you have sewn is counted and a graphic display lights and buzzer sounds when a preset number is reached. The stitch counter lets you know how much lower thread you have used and gives you an indication of sewing length. It can be used as a production counter as well.

- **Easy to view with no eye fatigue**

Because the panel uses a backlit LCD, the displays are easy to see. The glare from the operation panel surface has been eliminated, so that it is much less reflective and does not cause eye fatigue.

- **Examples of sewing using operation panel**

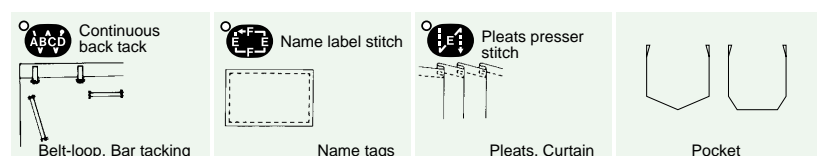

## Low noise and low vibration for stress-free operation

The sewing machine frame is highly rigid, and computer analysis has been used for designing everything down to the smallest detail, to create a shape which produces less noise and vibration. This reduces operator fatigue and greatly eliminates stress.

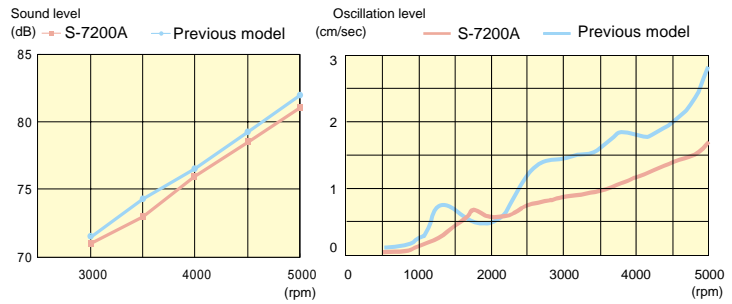

## Easy to maintain

- **Machine head can be tilted back easily**

Maintenance tasks that require the machine head to be tilted back have also been made safer. A safety sensor is provided to stop the motor from operating while the head is tilted, even if the treadle is depressed.

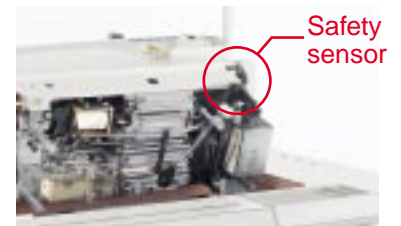

- **No lubrication required (-45°C)**

The complete dry-type head uses a lubrication-free rotary hook, and no oil is used around the needle bar, thread take-up or rotary hook mechanism. As a result, no lubrication is required at all.

- **Automatic greasing notification**

The running time for the sewing machine is recorded, and when it is time for the greasing maintenance that is indispensable for dry head sewing machines to be carried out, a notification appears automatically on the panel. (Use only special Brother grease to ensure excellent durability.)

- **Gearbox oil level can be checked at a glance**

The oil level inside the gearbox can be checked visually. In addition, the gearbox has a heat-discharging construction with fin.



## Premier energy-saving design in the industry

The brand new built-in direct-drive motor has an optimized design that utilizes magnetic field analysis, and is the most compact motor of its type in the industry. And instead of using a V-belt, the drive power is transmitted directly to the mechanisms with no losses, so that any losses in energy are reduced to an absolute minimum. This new motor has an energy-saving performance that is a further improvement on previous direct-drive motors. Compared to V-belt driven systems (AC servo motors), losses in efficiency are reduced by approximately 50%\* (compared to the previous Brother model), meaning that this model tops the industry in energy saving.

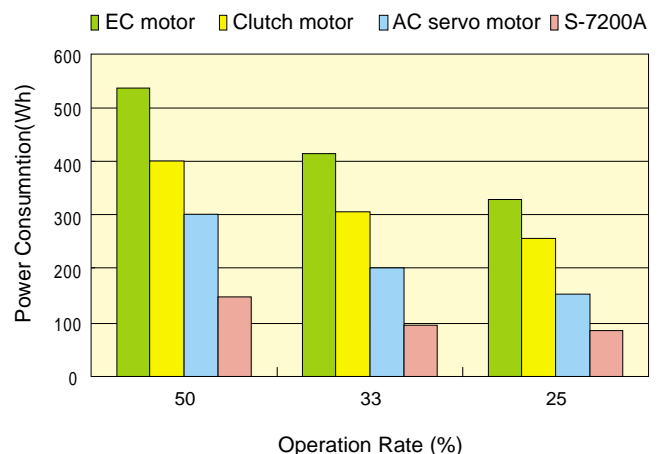

\* Sewing speed : 5,000 rpm

## Excellent material compatibility

- **Attractive sewing finishes for a wide range of materials**

The S-7200A has an optimized needle bar, thread take-up loci and feed loci. In addition, the adjustment range for the feed dog has been increased, allowing a greater range of different types of material to be sewn. Attractive finishes can be obtained with no puckering or slippage, even with materials that slip easily and stretch materials.

### Feed dog height adjustment range

	Previous model	S-7200A
-□□S	0.8mm	0.9-1.0mm
-□□3	1.0mm	1.1mm
-□□5	1.2mm	1.3mm

- **A penetration force boosting function lets you sew even heavy materials**

If the needle penetration resistance increases, such as when sewing heavy materials and materials with joints, vibration control automatically increases the penetration force. (Patent pending)

## Higher sewing quality

- **Optimized floating presser foot for long pile materials**

A micro-adjustable type floating presser foot is equipped as standard. This device is ideal for controlling presser foot floating in materials that stretch easily and materials with long pile. It prevents seam slippage and also prevents damage to the material. In addition, three-dimensional articles with irregular curves can also be handled with ease.

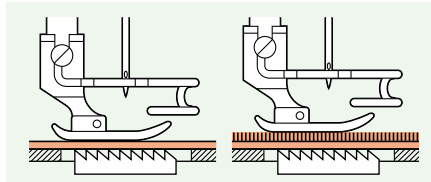

- **Adjustable tension release operation**

You can set whether or not the tension release operates when the presser foot is raised. Uniform thread tension can be obtained even while the presser foot is raised when sewing around corners, thus maintaining attractive finishes.

- **Presser foot pressure can reset easiling**

The presser foot adjustment screw has an adjustment scale. The presser foot pressure can be controlled numerically, so that you can reset it easily and accurately when required.



- **Stable thread trimming**

A rotary-type thread trimmer is used to provide stable thread trimming regardless of the type of material being sewn.



- **Condensed stitching is possible**

This feature is ideal for use when sewing thin materials that can easily pucker when reverse stitches are sewn. Condensed stitches have a smaller sewing pitch and they help prevent fraying.

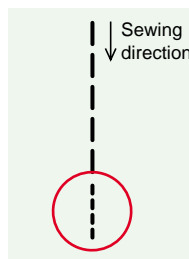

- **Because no V-belt is used belt shavings will not stain the material**

## Easy for operators to use

- **Smooth sewing with no hinge in the way**

The position of the machine head hinge has been shifted 150 mm to the right, on the other side of the needle bar from the operator.



- **Easy-to-operate bobbin winder**

The bobbin winder is located at the top of the sewing machine arm. This makes it easy to adjust the bobbin winding amount and to replace the bobbin.



- **Various commercially available attachments can be installed quickly and easily**

A variety of attachment taps are provided on the top of the bed.



## Easy for operators to use

### • Unobstructed view of needle area

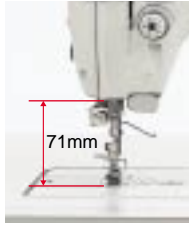

The height of the arm jaw is raised to 71mm. Plenty of space is provided around the needle so that the sewing area can easily be checked visually.

### • Extra space makes working more comfortable

Adoption of the direct-drive system means that there is no motor underneath the table. The extra space thus provided underneath the table can be effectively utilized to make working more comfortable.

### • Maximum presser foot lift amount 16 mm

The knee lifter and the needle up stop (reverse rotation) function together provide 16 mm of space underneath the presser foot. This makes it much easier to insert and remove heavy material without it getting caught on the needle.

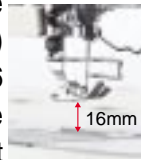

### • Selectable starting speed

The sewing speed at the sewing start can be selected in accordance with the treadle depression amount. You can set the speed according to the preferences of the operator.

### • Quickback device

### • Quickback device

This is located in a place where it can be pressed easily in order to increase working efficiency.



### • Easy pulley operation

The adoption of a compact motor means that the distance from the pulley to the operator is shorter 505mm, and so the pulley can be operated more easily.

## Wide arm pocket makes handling sewing articles easier

The S-7200A has an arm pocket width of 300 mm and an arm height of 136 mm. These wide arm pocket dimensions make it much easier to move and position the sewing article.



## Friendly to the environment

Brother has created its own "Brother Green Label" classification for products that conform to the ISO 14021 international industrial standard and the JIS Q14021 Japanese industrial standard. The S-7200A complete dry-type head conforms to this classification. The premier energy-saving design in the industry\*<sup>1</sup>, zero consumption of sewing machine oil and a 35% or more reduction in vibration\*<sup>2</sup> makes this a very environmentally friendly sewing machine.



Premier energy-saving design in the industry\*<sup>1</sup>  
Zero consumption of sewing machine oil  
35% or more reduction in vibration\*<sup>2</sup>

\*1 Comparison by Brother with other products in the same class as of February 2003.

\*2 Compared to previous DD7100 model.

## Ergonomic design provides ease of use down to the finest detail

The S-7200A is easy to understand, easy to operate and has an ergonomic design that eliminates operator fatigue. It has been designed from the point of view of the operator to emphasize ease of use.

## Options

### Material edge sensor

When this sensor detects the edge of the material, the cloth is automatically stopped in the specified position. This feature contributes to more even sewing finishes and increases working efficiency.

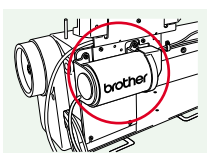

### Option switch

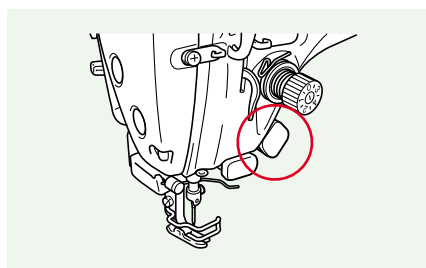

This can be set for use such as a bobbin thread counter reset or as a sewing speed select. It is located in a position where it can be easily pressed.



### Solenoid type presser foot lifter (Built-in head)

# Specifications

## S-7200A-

	Quick back	Thread wiper	Solenoid-type presser lifter		Lubrication type		Use				
					0	Minimum lubrication	S	For light-weight and difficult-to sew materials			
4	○	○	—		3	Semi dry	3	For medium-weight materials	★	★	★
					5	Complete dry	5	For heavy-weight materials			
Model		Lock stitch		1-needle		Thread trimmer					
S-7200A		★		★		★					

	— 403	— 405	— 43S	— 433	— 45S	— 453
Lubrication type	Minimum lubrication		Semi dry		Complete dry	
Use	For medium materials	For heavy materials	For light materials and difficult-to sew materials	For medium materials	For light materials and difficult-to sew materials	For medium materials
Max. sewing speed	5,000 rpm*1	4,500 rpm*1	4,000 rpm	5,000 rpm*1	4,000 rpm	4,000 rpm
Start backtacking and continuous backtacking speed	220-3,000 rpm					
End backtacking speed	220-3,000 rpm					
Max. stitch length	5mm	5mm	4.2mm	5mm	4.2mm	5mm
Presser foot height	Presser bar lifter 6 mm, Knee lifter 16 mm, (Solenoid-type presser lifter 10 mm)					
Needle bar stroke	31mm	35mm	29mm	31mm	29mm	31mm
Needle(DBx1· DPx5)	#11-#18	#19-#22	NS#9-#11	#11-#18	NS#9-#11	#11-#18
Rotary hook*2	Lubricated / for medium materials	Lubricated / for heavy materials	Lubricated / for light materials	Lubricated / for medium materials	Rotary hook RP (lubrication-free rotary hook)	Rotary hook RP (lubrication-free rotary hook)
Feed dog	4 row	4 row	4 row	4 row	4 row	4 row
Feed dog height	0.8mm	1.2mm	0.8mm	0.8mm	0.8mm	0.8mm
Weight	Machine head: 44kgf, Control box: 6.1kgf (low voltage) 9.2kgf (high voltage), Operation panel: 0.8kgf					
Arm pocket size	Arm pocket width: 300 mm, Arm height: 136 mm					
Arm bed size	517.5mm × 178mm					
Lubricating oil	Rotary hook	High-speed spindle		High-speed spindle		—
	Needle bar/ Thread take-up	High-speed spindle		Special Brother grease		Special Brother grease
Bobbin winder	Included in machine arm					
Machine head drive	Direct drive mechanism					
Motor	AC servo motor (4-pole, 450W)					
Control circuit	Microprocessor					
Power requirement Power consumption	Single-phase 100-120V, 200-240V, 3-phase 200-240V,380-415V Power rating 400VA					

A standing operation connector is equipped as standard.

\*1 When sewing at speeds of 4,000 rpm or higher, set the stitch length to 4.2 mm or less.

\*2 When using lubrication-free rotary hook, set the Max. sewing speed 4,000 rpm or less.

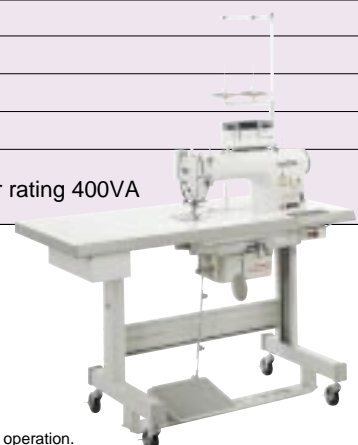

Product specifications are subject to change for improvement without notice. Please read instruction manual before using the machine for safety operation.

**brother**  
BROTHER INDUSTRIES, LTD.

15-1, Naeshiro-cho, Mizuho-ku, Nagoya 467-8561, Japan.  
Phone: 81-52-824-2177 Fax: 81-52-811-7789 <http://www.brother.com/>

ARCH SEWING  
215.627.1768  
[www.archsewing.com](http://www.archsewing.com)